

HARDINGE
COMPANIES
WORLDWIDE

Over the years, The Hardinge Group™ steadily diversified both its product offerings and operations. Today, the company has grown into a globally diversified player with manufacturing operations in North America, Europe and Asia. In addition to designing and building turning centers, and collets, Hardinge is a world leader in grinding solutions with the addition of the Kellenberger, Jones & Shipman, Hauser, Tschudin, Usach and Voumard brands to the Hardinge family. The company also designs and manufactures Bridgeport machining centers and other industrial products for a wide range of material cutting, turnkey automation and workholding needs.

Expect more from your Hardinge products. Choose Hardinge precision and reliability for increased productivity and value!

Call us today, we've got your answer.



Elgin, Illinois
Traverse City, Michigan
Elmira, New York

Leicester, England
Krefeld, Germany
Erkrath, Germany
Noisy-Le-Sec, France
St. Gallen, Switzerland
Bron, France
Biel, Switzerland

Wuhan, China
Beijing, China
Shenyang, China
Xian, China
Shanghai, China
Hyderabad, India
Chongqing, China
Guangzhou, China
Nan Tou, Taiwan
Jiaxing, China

North America

Hardinge Inc.
General Information: 607-734-2281
Sales Fax: 607.734.8819
Workholding Fax: 607.734.3886
Service: 800.424.2440
www.hardinge.com

Canada

Canadian Hardinge Machine Tools Ltd.
Tel: 800.468.5946
Fax: 607.734.8819

Mainland China

Hardinge Machine (Shanghai) Co. Ltd.
Hardinge China Limited
Tel: 0086 21 38108686
Fax: 0086 21 38108681

Hardinge Precision Machinery (Jiaxing) Co., Ltd.
Economic and Technology Development Zone
Tel: 0573-82601088
Fax: 0573-82601988

Germany

Hardinge GmbH
Tel: (49) 2151 496490
Fax: (49) 2151 4964999

India

Hardinge Machine Tools India LLP
SRS Arcade, 374/1, 9th Cross
Peenya Industrial Area,
Bengaluru-560 058
T.+91-80-41610853

Taiwan

Hardinge Machine Tools B.V.
Tel: 886 49 2260536
Fax: 886 49 2252203
cs@hardinge.com.tw

Switzerland

L. Kellenberger & Co. AG
Tel: +41 (0) 71 242 91 11
Fax: +41 (0) 71 242 92 22
info@kellenberger.com
www.kellenberger.net

L. Kellenberger & Co. AG
Tel: +41 (0) 32 344 11 52
Fax: +41 (0) 32 341 13 93
info@kellenberger.com
www.kellenberger.net

United Kingdom

Jones & Shipman Hardinge Limited
Tel: +44 (0) 116 2013000
Fax: +44 (0) 116 2013002
info@jonesshipman.com
www.jonesshipman.com



GS Series
High Precision CNC Lathes
High Precision CNC Turning Centers



All specifications subject to change without notice.
All marks indicated by ® and ™ are trademarks of their respective owners. #VM110B • Litho in USA
© Hardinge Inc. 2020 • June 2020



www.hardinge.com



OVERVIEW OF GS-SERIES

After years of market trials, Hardinge GS series CNC horizontal lathes and turning centers already become the symbol of high rigidity and high reliability CNC lathes. These mature machines are extremely cost-effective and provide you with a truly universal machine. GS series machines are configured into multiple machine models according to different needs, so that you can easily choose the machine that suits your needs. "Hardinge" has become a well-known machine tool brand in Asia. Choosing Hardinge can provide you with the best quality products and fast, professional machine tool maintenance and spare parts service.



GS 150 Plus
 Swing over way covers: 457mm
 Maximum turning length: 406mm
 Maximum turning diameter: 284mm
 Chuck size: 6" (169mm)
 Spindle speed: 6000rpm
 Spindle power: 11kW (S3 25%)



GS 200 Plus
 Swing over way covers: 457mm
 Maximum turning length: 406mm
 Maximum turning diameter: 284mm
 Chuck size: 8" (210mm)
 Spindle speed: 5000rpm
 Spindle power: 11kW (S3 25%)



GS 200/66 Plus
 Swing over way covers: 595mm
 Maximum turning length: 600mm
 Maximum turning diameter: 356mm
 Chuck size: 8" (210mm)
 Spindle speed: 4200rpm
 Spindle power: 18.5kW (S3 25%)
 Spindle torque: 335Nm (S3 25%)



GS 250 Plus
 Maximum swing diameter: 595mm
 Maximum turning length: 600mm
 Maximum turning diameter: 356mm
 Chuck size: 10" (254mm)
 Spindle speed: 3500rpm
 Spindle drive power: 18.5kW (S3 25%)
 Spindle drive torque: 401Nm (S3 25%)



GS 200/66 L Plus
 Swing over way covers: 595mm
 Maximum turning length: 1050mm
 Maximum turning diameter: 356mm
 Chuck size: 8" (210mm)
 Spindle speed: 4200rpm
 Spindle drive power: 18.5kW (S3 25%)
 Spindle drive torque: 335Nm (S3 25%)



GS 250 L Plus
 Swing over way covers: 595mm
 Maximum turning length: 1050mm
 Maximum turning diameter: 356mm
 Chuck size: 10" (254mm)
 Spindle speed: 3500rpm
 Spindle power: 18.5kW (S3 25%)
 Spindle torque: 401Nm (S3 25%)

GS 150M Plus
 Maximum turning length: 406mm
 Maximum turning diameter: 284mm
 Chuck size: 6" (169mm)
 Spindle speed: 6000rpm
 Spindle power: 11kW (S3 25%)
 Driving tool speed: 5000rpm
 Driving tool specifications: VDI30
 Driving tool power: 3.7kW

GS 200M Plus
 Maximum turning length: 406mm
 Maximum turning diameter: 284mm
 Chuck size: 8" (210mm)
 Spindle speed: 6000rpm
 Spindle drive power: 11kW (S3 25%)
 Driven tool speed: 5000rpm
 Driven tool specifications: VDI30
 Driven tool power: 3.7kW

GS 200/66M Plus
 Maximum turning length: 600mm
 Maximum turning diameter: 326mm
 Chuck size: 8" (210mm)
 Spindle speed: 4200rpm
 Spindle power: 18.5kW (S3 25%)
 Spindle torque: 335Nm (S3 25%)
 Driven tool speed: 4000rpm
 Driven tool specifications: BMT65

GS 250M Plus
 Maximum turning length: 600mm
 Maximum turning diameter: 326mm
 Chuck size: 10" (254mm)
 Spindle speed: 3500rpm
 Spindle drive power: 18.5kW (S3 25%)
 Spindle drive torque: 401Nm (S3 25%)
 Driven tool speed: 4000rpm
 Driven tool specifications: BMT65

GS 200/66M L Plus
 Maximum turning length: 1050mm
 Maximum turning diameter: 326mm
 Chuck size: 8" (210mm)
 Spindle speed: 4200rpm
 Spindle power: 18.5kW (S3 25%)
 Spindle torque: 335Nm (S3 25%)
 Driven tool speed: 4000rpm
 Driven tool specifications: BMT65

GS 250M L Plus
 Maximum turning length: 1050mm
 Maximum turning diameter: 326mm
 Chuck size: 10" (254mm)
 Spindle speed: 3500rpm
 Spindle power: 18.5kW (S3 25%)
 Spindle torque: 401Nm (S3 25%)
 Driven tool speed: 4000rpm
 Driven tool specifications: BMT65

WIDE RANGE OF APPLICATIONS

Hardinge GS series machines are widely used in many fields such as automobiles, hydraulics, aerospace, medical, electrical appliances, construction machinery, etc., With their high reliability, continuous accuracy retention and outstanding processing efficiency, Complete pre-heat finishing of small and medium parts. Regardless of the production mode of single-piece small batch or mass production line, GS series machines can perform all tasks well.



Gear Finishing
 One time clamping, processing completed, Ensure that the tooth jumps 0.02mm, End jump 0.01mm



Differential housing
 Complete all the processing of the difference shell in order, Ensure that the position of the flange surface and the journal at both ends is 0.02mm, Journal diameter tolerance 0.03mm, CPK ≤ 1.33



Parts: Pump body
 Machining content: Inner cavity, end surface machining
 Material: QT450
 Machining accuracy: level 7



Parts: Impeller
 Machining content: hole processing
 Material: Aluminum alloy
 Machining accuracy: level 6



Valve precision parts
 Diameter tolerance 0.01mm, Concentricity 0.015mm, Surface finish Ra0.8



Gear Shaft
 Finishing
 One-time clamping to complete all parts processing

EFFICIENCY, PRECISION, AND DURABLE GS SERIES

GS series machines combine multiple configurations within a compact structural framework and a competitive price range, so as to improve processing efficiency, processing accuracy and machine durability.



HIGHER PROCESSING EFFICIENCY

Faster machining cycle time, lower non-cutting time

- High spindle speed, 6000rpm for GS 150 Plus machine, 5000rpm for GS 200 Plus machine, 4200rpm for GS 200/66 Plus (L) machine, 3500rpm for GS 250 Plus (L) machine
- Fast moving speed, fast moving speed of X, Z axis Up to 30m/min
- Fast tool change, GS series machines use servo turrets, tool change time of GS 150 Plus and GS 200 Plus machines is 0.09 seconds (rotation only), GS 200/66 Plus (L) and GS 250Plus (L) machines Tool change time is 0.10 seconds (rotation only)



HIGH RIGIDITY MACHINE STRUCTURE

Longer tool life and greater heavy-duty cutting capacity

- The sturdy, high-rigidity bed adopts an integrated slant structure, high-quality gray cast iron material, and a thick rib structure. The GS 150 Plus and GS 200 Plus machine body is a 45-degree slant body, GS 200/66Plus (L) And GS 250 Plus (L) machine bed is a 30-degree inclined body.
- Hardinge's engineering team uses FEA (Finite Element Analysis) technology during the design process to balance the overall rigidity of the machine and ensure excellent machine rigidity and life.
- C2 precision ball screw with double-nut structure pre-tightened, hardened and finely ground to reduce noise and thermal expansion.
- Heavy-duty linear guides increase rigidity by more than 30% and longer machine life



EXCELLENT AND STABLE ACCURACY

Stable static and dynamic cutting accuracy

- X/Z axis full stroke positioning accuracy 0.01 mm (ISO 230-2)
- X/Z axis full stroke repeat positioning accuracy 0.005mm (ISO 230-2)
- Processing example:
 - Material BsB, spindle speed 1250rpm
 - Processing roundness 0.7 μm
 - Surface roughness Ra0.2 μm



COMPACT STRUCTURE

Minimized floor space and maximum working space

- Compact machine appearance
GS 150 Plus and GS 200 Plus machine length 1998mm, GS 200/66 Plus and GS250Plus machine length 2988mm, GS 200/66 L and GS 250 L length 3792mm
- Efficient use of space
Work Space machine space area ratio is as high as 3.5%, which is better than the average value of 2.94%

MACHINING EXAMPLE

Machine Type	GS 150 Plus	GS 200 Plus	GS 200/66 Plus (L)	GS 250 Plus (L)
Machine Type	GS 150 Plus	GS 200 Plus	GS 200/66 Plus (L)	GS 250 Plus (L)
Workpiece material	Heavy-duty machining S45C	Heavy-duty machining S45C	Heavy-duty machining S45C	Heavy-duty machining S45C
Line speed	150m/min	150m/min	200m/min	200m/min
Cutting depth	3.5mm	4mm	5mm	6mm
Feed rate	0.45mm/rev	0.45mm/rev	0.4mm/rev	0.4mm/rev
Material removal rate	235cc/min	270cc/min	400cc/min	480cc/min

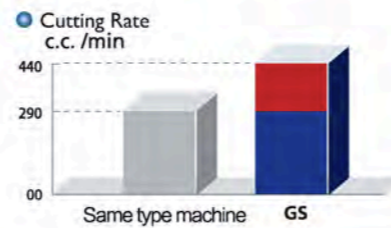
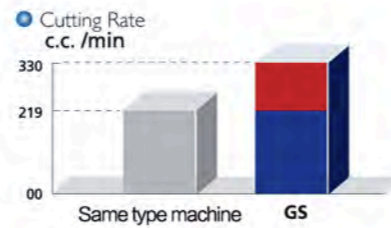

Ball Type linear guide

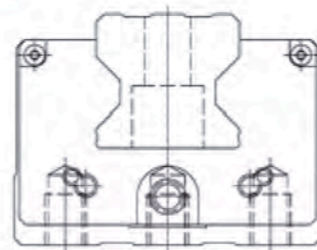

Examples of roundness processing detection

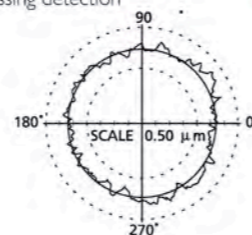

Surface roughness

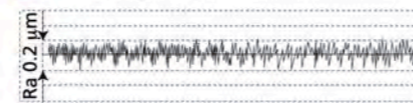

MACHINE STRUCTURE

Most reliable servo motor and drive system in the industry. Efficient servo motors and drive systems provide excellent machine processing capabilities.

Standard 12-tool T-type turret, VDI-type turret with or without power tool function are available as options.

Non-contact magnetic encoder does not need a belt, which improves the overall reliability.

The optimal spindle design within the same level integrates two double-row roller bearings and two angular contact ball bearings to ensure excellent rigidity, thermal stability and spindle life. The dual-winding spindle motor provides efficient heavy-duty cutting capabilities.

The machine body and all castings are made of high-quality gray cast iron, with excellent rigidity, durability and thermal stability.

Standard 12-tool T-type turret, VDI turret with power tool function is available as an option.

High-grade double-nut ball screws ensure excellent machine accuracy and repeatability.

The 45-degree overall sloping body design with additional reinforcement is used.

STANDARD CONFIGURATION:

- 3-jaw chuck(including a pair of soft jaws)
- Spindle reference point (servo lock)
- Rigid tapping
- Running time and workpiece counter
- Spindle clamp/unclamp foot switch
- Chip conveyor interface
- Swivel CNC panel
- Air gun(including quick-change connector)

GS 200/66 PLUS(L), GS 250 PLUS(L)

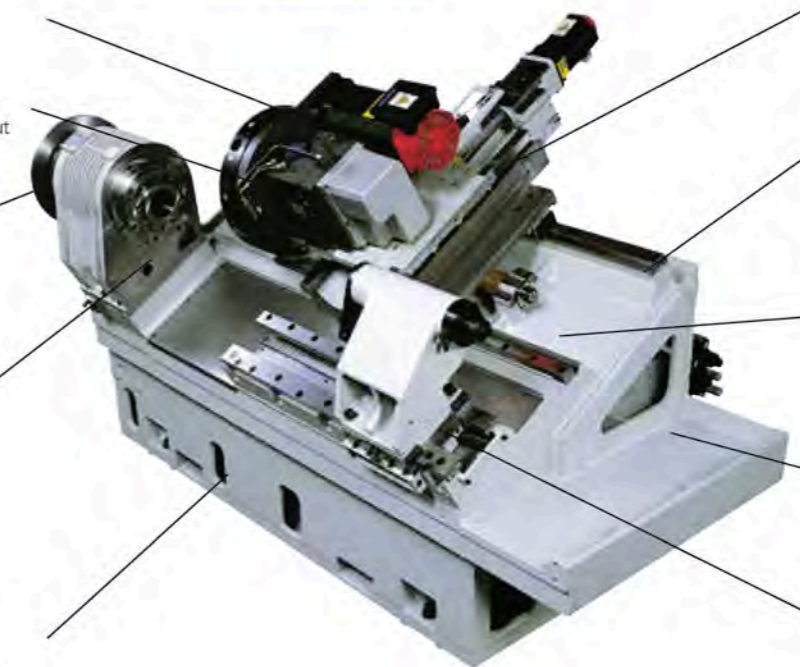

The environmentally friendly centralized grease lubrication system minimizes overall machine maintenance costs.

Heavy-duty linear guide system provides optimized rigidity. The immediate advantage is greater heavy-duty cutting capacity and longer machine life.

Heavy-duty double-nut screw with fixed pretension, guarantees excellent rigidity, machine precision and repeatability.

The 30-degree overall inclined body design with additional reinforcement is used.

Fully programmable Morse No. 5 hydraulic tailstock adopts a thick rectangular hard rail design to make the tailstock have the optimal rigidity.

All machines are laser tested in accordance with strict quality standards.

GS 150 PLUS, GS 200 PLUS

The configurations and advantages listed above also apply to the GS 150 Plus and GS 200 Plus models.

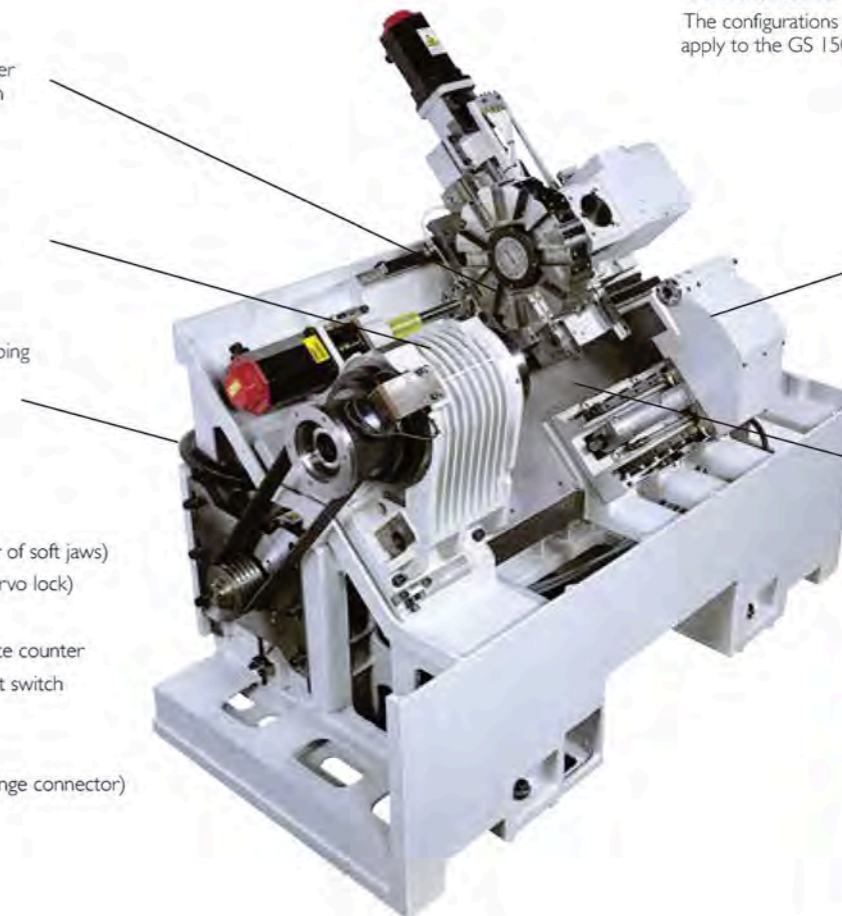

Fully programmable Morse No. 4 hydraulic tailstock eliminates manual intervention compared to other types of tailstock.

High-quality linear guides ensure higher machine positioning accuracy, faster feed rate, less machine wear, longer machine life and comprehensive machining continuity.

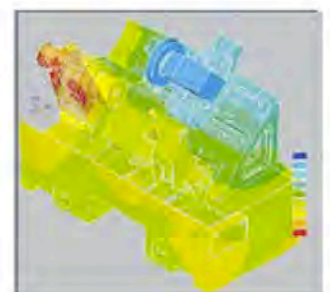

12-TOOL VERTICAL TYPE TURRET — SUITABLE FOR CNC LATHES

POWER TURRET

TOOL INTERFERENCE MINIMIZATION

Bi-directional tool change function can make the turret perform the tool change according to the shortest tool change order to reduce the non-cutting time. The non-lifting tool change action of the turret can effectively prevent chips from entering the interior of the turret. The indexing is driven by a brushless servo motor, and the locking is hydraulically locked by a 3-piece end gear disc. The turret pin (which can be safely cut off) configuration helps prevent machine damage when a crash occurs. The coolant can enter the round shank tool holder through the interface on the tool head, so that the coolant is accurately sprayed in the cutting area.

RIGID TAPPING

The spindle and Z-axis movements are synchronized for precise and fast rigid tapping operations.

WIDE WORKING AREA

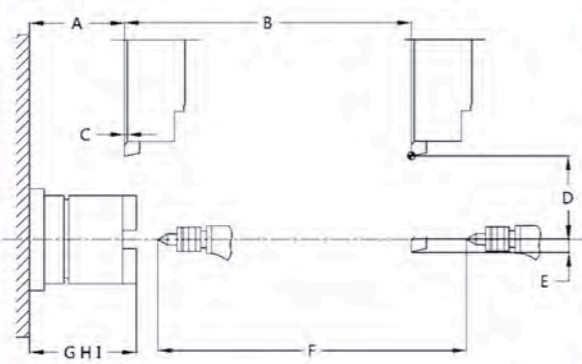
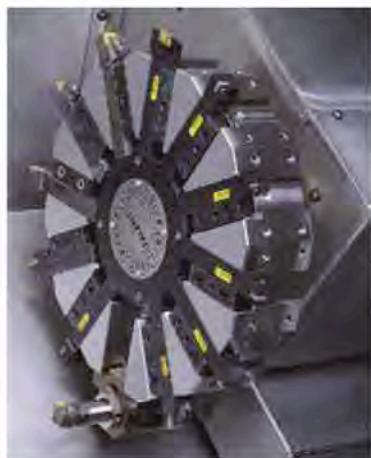

GS 150 Plus and GS 200 Plus	
A 162.5mm (6.398")	B 406.0mm (15.984")
C 10.0mm (.394")	D 152.0mm (5.984")
E 11.0mm (.433")	F 341.0mm (13.425")
G 182.5mm (7.185")	H 207.5mm (8.169")
I —	

GS 200/66 Plus and GS 250 Plus	
A 186.5mm (7.340")	B 600.0mm (23.622")
C 10.0mm (.394")	D 210.5mm (8.288")
E 16.0mm (.630")	F 625.0mm (24.606")
G —	H 207.5mm (8.169")
I 231.5mm (9.114")	

GS 200/66 L and GS 250 L	
A 186.5mm (7.340")	B 1050.0mm (41.34")
C 10.0mm (.394")	D 210.5mm (8.288")
E 16.0mm (.630")	F 1075.0mm (42.322")
G —	H 207.5mm (8.169")
I 231.5mm (9.114")	

*Add 120mm (4.724") sleeve travel

MINIMIZED TOOL INTERFERENCE

GS 150 Plus, GS 200 Plus

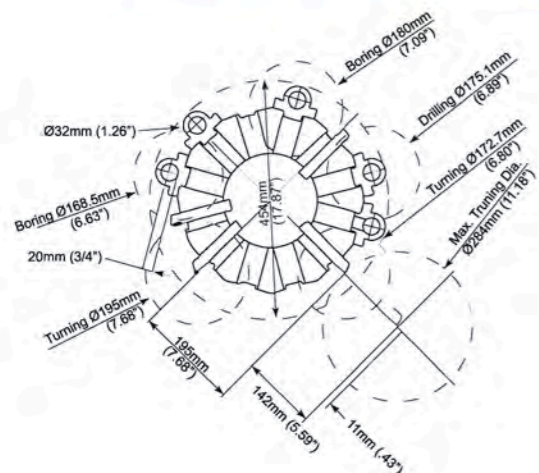

GS 200/66 Plus (L), GS 250 Plus (L)

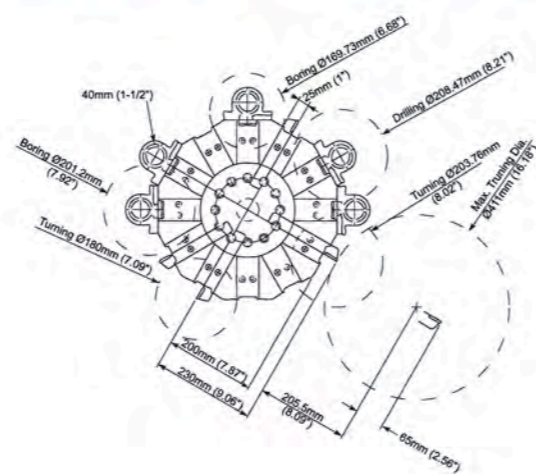

SUITABLE FOR TURNING CENTERS

The 12 tool position VDI 30 turret with bi-directional tool change function (GS 200/66Plus (L) and GS 250 Plus (L) models with VDI40 turret) can be changed in the shortest tool change order to reduce non-cutting time. Because there are sufficient tool stations, it is easier to process the parts group and the commissioning time is shorter. Quick-change tool setting can be performed by using the quick-change VDI tool holder. The non-lifting turret tool change action can effectively prevent pollutants from entering the turret. The indexing is driven by a brushless servo motor, and the lock is hydraulically locked by a 3-piece end gear disc. The turret pin (which can be safely cut off) configuration helps prevent machine damage. The coolant enters the tool holder through the port on the cutter head, so that the operator can directly spray the coolant into the machining area to improve the cutting performance and chip removal performance. Combined dynamic tool function and rigid tapping function.

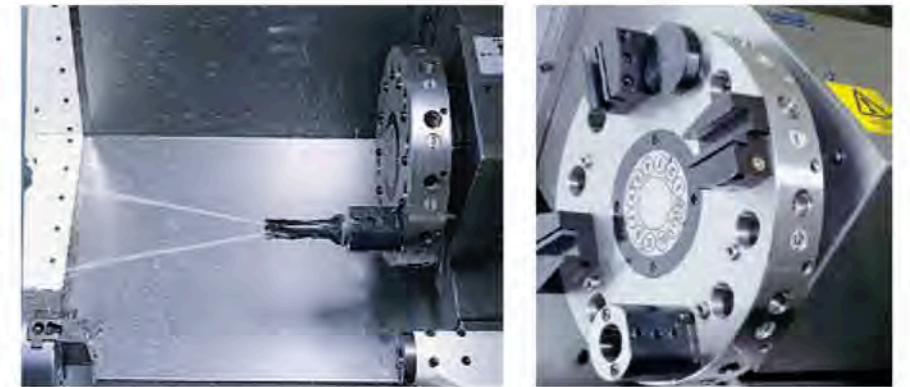

WIDE WORKING AREA

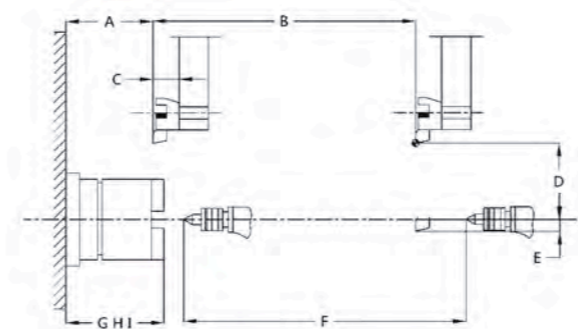

GS 150 Plus and GS 200 Plus	
A 162.5mm (6.398")	B 406.0mm (15.984")
C 47.0mm (1.850")	D 142.0mm (5.594")
E 76.0mm (2.992")	F 341.0mm (13.425")
G 182.5mm (7.185")	H 207.5mm (8.169")
I —	

GS 200/66 Plus and GS 250 Plus	
A 179.5mm (7.067")	B 600.0mm (23.622")
C 47.0mm (1.850")	D 188.0mm (7.402")
E 93.5mm (3.681")	F 24.606"/62.5.0mm
*G —	H 207.5mm (8.169")
I 231.5mm (9.114")	

GS 200/66 L and GS 250 L	
A 179.5mm (7.067")	B 1050.0mm (41.34")
C 47.0mm (1.850")	D 188.0mm (7.402")
E 93.5mm (3.681")	F 1075.0mm (42.322")
*G —	H 207.5mm (8.169")
I 231.5mm (9.114")	

Add 120mm (4.724") sleeve travel

GS 150M Plus and GS 200M Plus

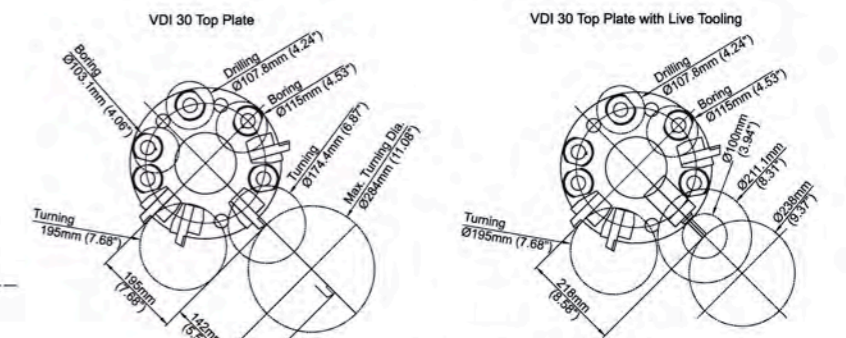

The cutter head of this structure does not need to consider the interference of adjacent cutter seats when processing large-diameter parts. It is recommended to consider the weight balance installation when installing the knife.

GS 200/66M Plus(L) and GS 250M Plus(L)

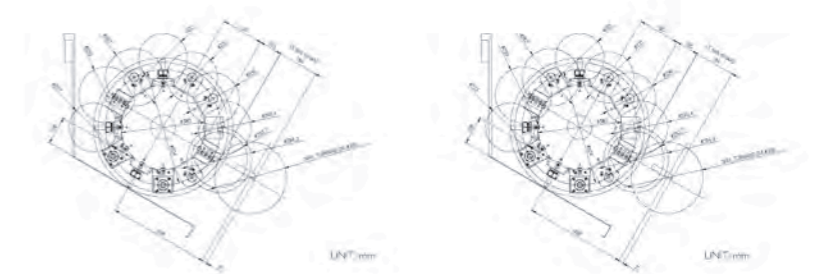

BMT66 turret tool interference diagram

TOOL INTERFERENCE DIAGRAM BMT65

MACHINE CONFIGURATION

Configurations and options to enhance machine processing capabilities

HYDRAULIC TAILSTOCK (STANDARD)

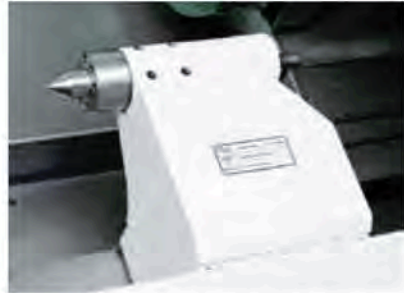

GS 150 Plus GS 200 Plus

GS series machines are equipped with programmable hydraulic tailstock. The tailstock adopts a solid monolithic design, which provides higher stability when machining top parts with top-notch, which can achieve tighter tolerances, better surface roughness, higher spindle speed and feed speed. The tailstock adopts hydraulic drive positioning, which can be automatically controlled by part program or manually controlled by keys on the operation panel.

The GS 150 Plus and GS 200 Plus machines are equipped with MT#4 integral tailstock, with a maximum thrust of 3470N (as shown on the left).

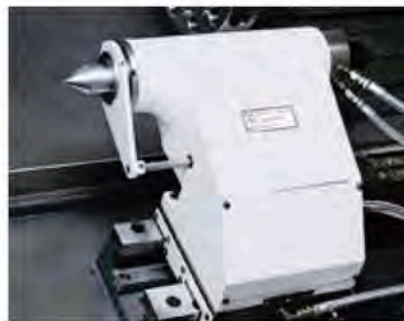

GS 200/66 Plus(L) GS 250 Plus(L)

GS 200/66 Plus and GS 250 Plus machines are equipped with MT#5 sleeve tailstock, sleeve stroke is 120mm, and the maximum thrust is 9354N (as shown on the left).

The tailstock of all models can move at a feed rate up to 5.5mm/min.

ENHANCED MOVABLE TAILSTOCK (OPTIONAL)

Using MT4 center enhances the precision of center rigidity and effectively extends the lifecycle of centers.



STEADY REST (OPTIONAL)

It is feasible for GS 200/66 Plus (L) and GS 250 Plus (L) machine tools to choose a hydraulic steady rest to support long-axis parts. The rest has a self-centering function that allows greater cutting force and reduces vibration, maintain parts tolerance and surface roughness.

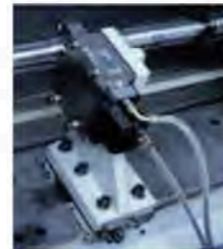

OTHER STANDARD CONFIGURATION :

- Fanuc Oi TF control system
- Dynamic graphic display
- Spindle labyrinth seal
- Heavy-duty linear guide
- Centralized automatic grease lubrication
- system 3-color stack light
- Three-jaw chuck (incl. a pair of soft jaws)

20BAR HIGH-PRESSURE COOLANT THROUGH TURRET (OPTIONAL)

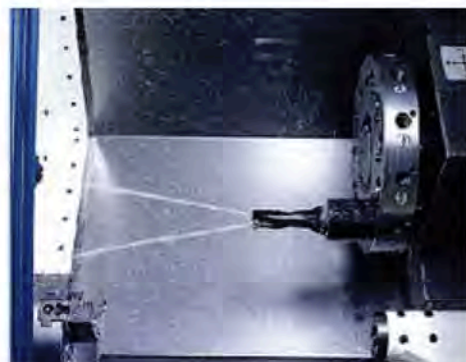

The picture shows the VDI turret

During the actual machining, the coolant pressure of the turret up to 20Bar can make the coolant directly act in the cutting area, greatly improving the chip removal capacity, can achieve a higher cutting feedrate and spindle speed, and effectively maintain a lower processing temperature. Thereby extending the life of the tool and obtaining a better surface roughness.

DRIVING TOOL AND C AXIS

GS 150M Plus and GS 200M Plus machine tools are equipped with VDI30 type 5000rpm power tool function, GS 200/66M Plus (L) and GS250M Plus (L) machines are equipped with BMT type 4000rpm power tool function, which can complete the turning and milling process in one clamping, effectively reducing the cost of parts clamping and debugging, and can better ensure the position accuracy of parts.

All tool positions of the turret can be equipped with powered tool holders, however only driven tool holders in the current tool position can be driven. Turret tool change and power tool drive are driven by independent servo motors.



The spindle is equipped with the C-axis function, which can be independently moved or interpolated with the X or Z axis to realize milling, drilling, tapping and other operations on the end face or diameter of the part.

The spindle is equipped with a disc hydraulic brake system, which can lock the spindle when the spindle is fixed and perform milling operations.



The C axis can realize the positioning function with a resolution of 0.001 degrees. Applications such as three-dimensional contours, complex circular and prismatic machining, square shoulders, and lettering can all be achieved through linkage interpolation between the spindle and the X and Z axes. The rigid tapping function can be realized on the axial power tools or the radial power tools.

PART CATCHER



Arm type

The option allows the operator to easily recover finished parts from outside the machining area during the machining process. GS series machine tools have two types of part catchers, one is the arm type, which is suitable for the full range of GS machine tools, including a set of parts transfer device, which can transfer parts from the machine to the left side of the machine; The other is the slide type catchers, which is suitable for GS150 Plus and GS 200 Plus. It can place the finished parts in the silo located on the main door of the machine.

TOOL PROBE (OPTIONAL)

The automatically retractable tool setting arm is convenient for quick setting and easy to use, and can automatically input tool offsets into the control system. The four-way probe is suitable for all external and internal tools. The machine can also be programmed to realize automatic tool setting, which is used to compensate tool wear or tool breakage detection during the machining cycle. The tool setting arm can swing to the storage position on the side wall of the spindle.

OPTICAL SCALES (OPTIONAL)

The X and Z axis optical scales options can improve the overall thermal stability of the machine tool, minimize the time for the machine tool to reach thermal equilibrium, and improve the size fluctuations of the parts caused by the heat accumulation of the machine. This option makes the machine more stable and requires less manual intervention to modify the tool compensation during the machine's operation.

OTHER OPTIONS

- Chip conveyor
- Bar feeder
- Automatic power-off
- Oil mist collector
- Automatic door
- Live Center
- High pressure coolant through turret
- 20Bar/50Bar/70Bar Spindle air blowing seal

Powerful Spindle driving system
Improve the cutting capacity and efficiency of GS machines

GS 150 Plus/GS 150M Plus

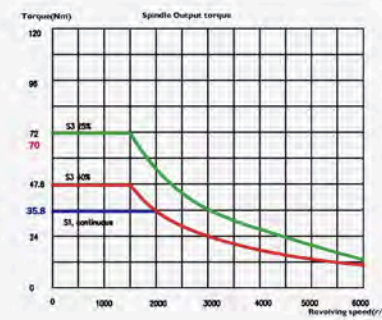
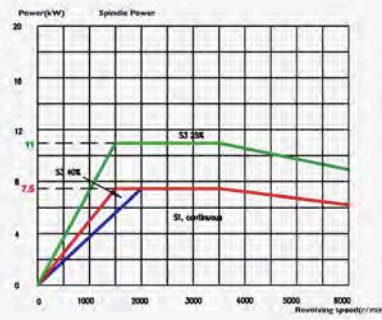

GS 200 Plus/GS 200M Plus

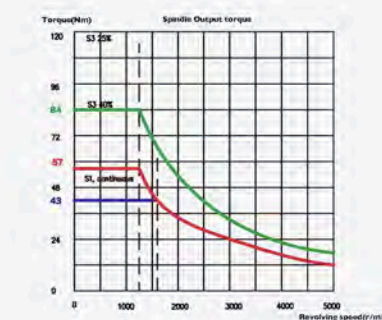
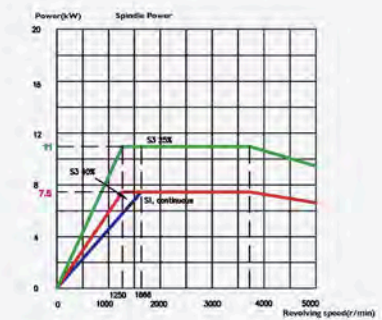

GS 200/66 Plus/GS 200/66L
GS 200/66M Plus/GS 200/66M L

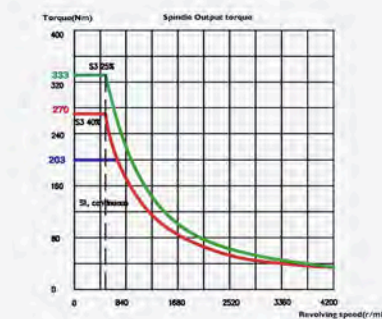
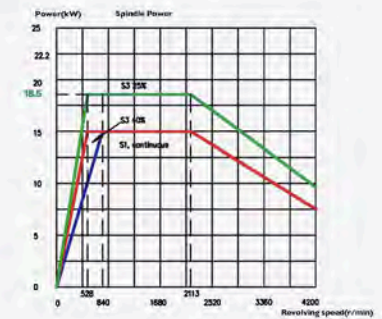

GS 250 Plus/GS 250L
GS 250M Plus/GS 250M L

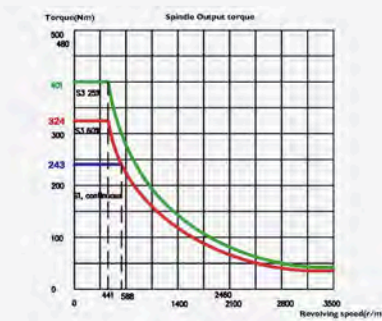
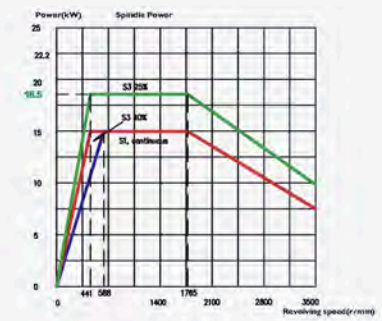

Fanuc Oi TF Plus Control System

General Function

- Servo Control HRV3
- Two-axis interpolation
- Programming Resolution 0.001mm
- Least input increment- 0.001mm (nano interpolation)
- G code Metric/Imperial Conversion
- Detection of travel limit before moving
- Multi Language display Chinese

Data input / output

- MDI Process
- PCMCIA Interface
- Embedded Ethernet (100base)
- USB interface

Run Operation

- Automatic Operation (memory)
- MDI Run
- DNC Run
- CF Card DNC Operation
- Program number search
- Sequence number search
- Sequence number comparison and stop
- Dry Run
- Single block operation
- JOG feed
- Stop option

Interpolation function

- Linear interpolation
- Circular interpolation
- Thread cutting
- Variable pitch thread cutting
- Thread cutting back
- G31 jump
- High speed skip
- Return to reference point

Feed Function

- Rapid Feeding Override
- Feed per min / per cycle
- Fixed Tangential Speed
- Automatic acceleration/deceleration
- Feed rate override
- JOG magnification

Program input

- Absolute / incremental instructions
- Coordinate Setting
- Coordinate system offset
- Direct input of drawing size
- Chamfer/Corner R
- Programmable Data Input
- Subroutine Instruction Call
- Turning cycle I
- Turning cycle II
- User Macro Program
- Additional user macro program common variables
- Graphical dialogue input

Tool function / Tool compensation function

- Tool offset pairs, 128pairs
- Tool position offset
- Tool nose radius compensation
- Tool life management

Edit Operation

- Program memory capacity 2MB
- Number of registered programs 1000
- Extension editing
- Background editing
- Memory card editing and running

Setting / Display

- 10.4" display
- Run time display/Parts count display
- Help function
- Self-diagnosis function
- Graphic display
- Dynamic graphic display

GS MACHINE TOOLING

Hardinge is not only a precision machine tool manufacturer, but also one of the world's most complete tooling and fixture system manufacturers, with more than a century of tooling manufacturing experience. Hardinge's complete and rich tooling product line covers precision three-jaw chucks, spring chucks, quick-change spindle tooling and CNC turntables.

Hardinge GS machine is equipped with a three-jaw chuck (wedge type) as standard, and a variety of precision spindle tooling caalso be selected to further enhance the processing capacity and scope of the machine.



Sure-Grip[®] three-jaw chuck

Hardinge Sure-Grip three-jaw chuck adopts a lever-type structure, which effectively eliminates the influence of centrifugal force on the performance of the chuck, and is dynamically balanced. The maximum speed is higher than that of similar products.



Dead-Length[®] Systems

Maintain part-length control by using Hardinge dead-length systems. Choose from dead-length collet assemblies, thru-hole collets, step chucks and spider-stop step chucks. I6C to #22 B&S adapter shown on A2-5 sub-spindle.



Spring chuck adapter

I6C, 3J, 5C (applicable to GS150 Plus), I6C, 3J (applicable to GS200 Plus), back-pull structure, can use Hardinge precision spring chuck.



FlexC[™] Quick-Change Vulcanized Collet Systems

Interchangeable quick-change vulcanized collet heads have a working range of ± 0.5mm to accept bar stock variation. Collets change in seconds, while accuracy is maintained at 0.01mm.



Forward push chuck adapter

DIN standard forward push chuck adapter, can use integral DIN6343 chuck or split type B spring with S-shaped pad claw chuck.



Spindle nose conversion adapter

A2-5 to A2-5 I6C (GS 150 Plus) A2-6 to A2-5 I6C (GS 200 Plus) on the premise of continuing the spindle accuracy, expand the interface range of the spindle.



Sure-Grip[®] internal expansion chuck

Hardinge Sure-Grip internal expansion chuck system provides a high-precision, true parallel clamping internal hole clamping program. According to different machine tool models, two types of chuck seat installation and spindle outer cone installation can be selected.



Ladder chuck and adapter

The stepped chuck is used for precision clamping of large diameter parts, and only a short length is required to provide sufficient clamping force. There can be multiple clamping surfaces and positioning surfaces on the same chuck, which can realize the turning processing of parts or the processing of multiple types of parts, and even meet the special clamping requirements of special-shaped parts and eccentric parts.

MACHINE SPECIFICATIONS

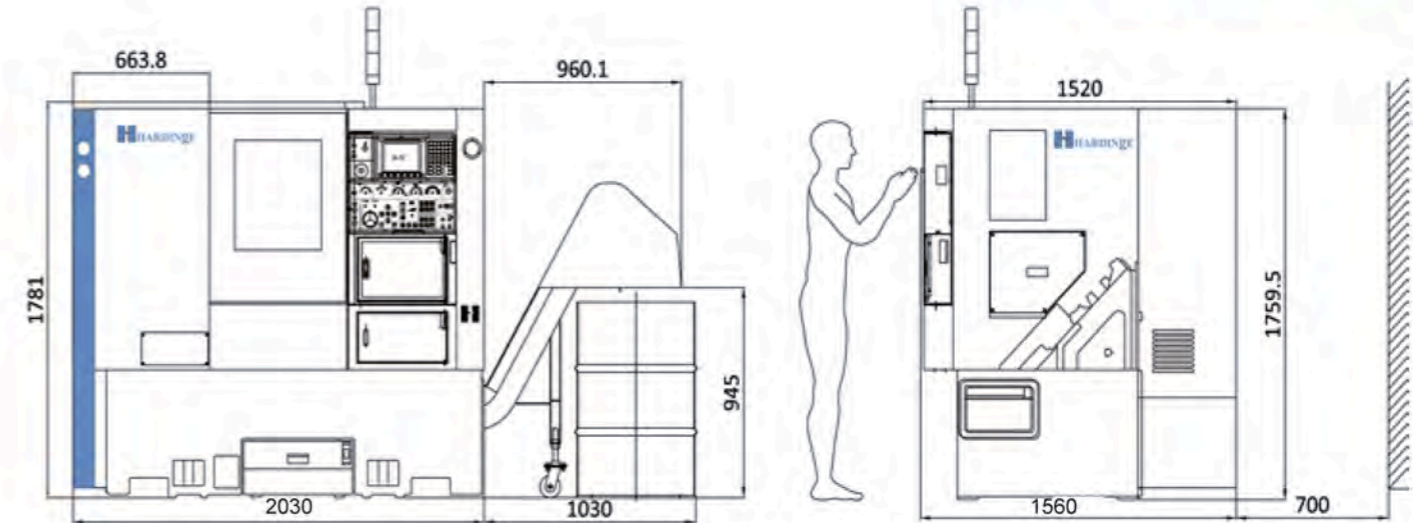

	GS 150 Plus	GS 200 Plus	GS 150M Plus	GS 200M Plus	
Spindle					
Spindle nose	A2-5	A2-6	A2-5	A2-6	
Spindle hole diameter	56	62	56	62	mm
Three-jaw chuck holding capacity	6"Ø150	8"Ø200	6"Ø150	8"Ø200	mm
Draw tube clamping	Hydraulic	Hydraulic	Hydraulic	Hydraulic	
Driving System					
Spindle motor power	7.5/11	7.5/11	7.5/11	7.5/11	kW
Spindle max. speed	6000	5000	6000	5000	rpm
Spindle output torque	70/15min	84/15min	70/15min	84/15min	Nm
X axis servo motor power	1.2	1.2	1.2	1.2	kW
Z axis servo motor power	1.2	1.2	1.2	1.2	kW
Processing Range					
Swing over way covers	460	460	460	460	mm
Max. turning length	406	406	406	406	mm
Max. machining diameters	274	274	284	284	mm
Through draw tube bore diameter	Ø45	Ø52	Ø45	Ø52	mm
X/Z axis					
X axis travel (VDI turret)	218	218	218	218	mm
X axis travel (T-type turret)	153	153	—	—	mm
Z axis travel	406	406	406	406	mm
X/Z axis rapid traverse rate	30	30	30	30	m/min
Turret					
Driver of turret	Servo motor	Servo motor	Servo motor	Servo motor	
Number of tool stations	12	12	12	12	
Square shark size	20	20	20	20	mm
Boring tool holder dia.	32	32	32	32	mm
Tool change time (T-T)	0.5	0.5	0.3	0.3	sec
Driving tool speed	—	—	5000	5000	rpm
Driving tool power	—	—	3.7	3.7	kW
Coolant system					
Cool tank capacity	125	125	125	125	L
Cut pressure	2.8	2.8	2.8	2.8	bar
Machine Size					
Length*Width*Height	2030×1560×1850	2030×1560×1850	2030×1560×1850	2030×1560×1850	mm
Weight	3150	3150	3150	3150	kg
Tailstock					
Taper center	MT4	MT4	MT4	MT4	
Tailstock travel	340	340	340	340	mm
Maximum holding workpiece length	410	410	410	410	mm
Rapid traverse	5.5	5.5	5.5	5.5	m/min

*All specifications subject to change without notice.

MACHINE SPECIFICATIONS

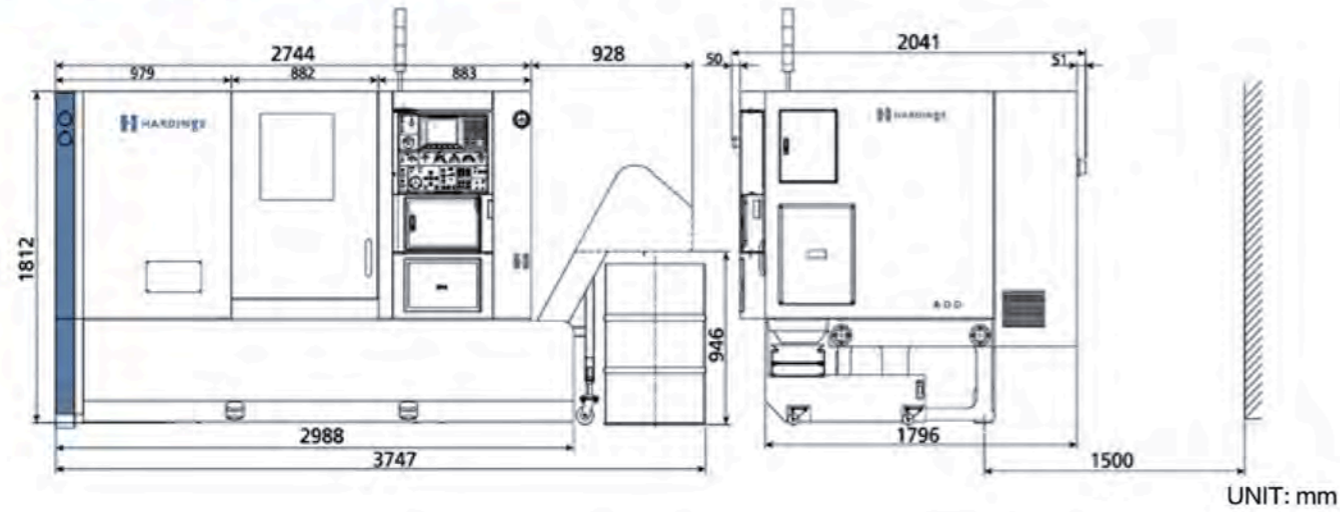

	GS 200/66 Plus	GS 250 Plus	GS 200/66M Plus	GS 250M Plus	
Spindle					
Spindle nose	A2-6	A2-8	A2-6	A2-8	
Spindle hole diameter	76	89	76	89	mm
Three-jaw chuck holding capacity	8"Ø200	10"Ø254	8"Ø200	10"Ø254	mm
Draw tube clamping	Hydraulic	Hydraulic	Hydraulic	Hydraulic	
Driving System					
Spindle motor power	15/18.5	15/18.5	15/18.5	15/18.5	kW
Spindle max. speed	4200	3500	4200	3500	rpm
Spindle output torque	335/15min	401/15min	335/15min	401/15min	Nm
X axis servo motor power	1.8	1.8	1.8	1.8	kW
Z axis servo motor power	3	3	3	3	kW
Processing Range					
Swing over way covers	650	650	650	650	mm
Max. turning length	580	560	580	560	mm
Max. machining diameters	411	411	326	326	mm
Through draw tube bore diameter	Ø66	Ø78	Ø66	Ø78	mm
X/Z axis					
X axis travel (BMT turret)	—	—	217	217	mm
X axis travel (T-type turret)	216.5	216.5	—	—	mm
Z axis travel	600	600	600	600	mm
X/Z axis rapid traverse rate	30	30	30	30	m/min
Turret					
Driver of turret	Servo motor	Servo motor	Servo motor	Servo motor	
Number of tool stations	12	12	12	12	
Square shark size	25	25	25	25	mm
Boring tool holder dia.	40	40	40	40	mm
Tool change time (T-T)	0.3	0.3	0.3	0.3	sec
Driving tool speed	—	—	4000	4000	rpm
Driving tool power	—	—	5.5	5.5	kW
Coolant system					
Cool tank capacity	290	290	290	290	L
Cut pressure	2.8	2.8	2.8	2.8	bar
Machine Size					
Length*Width*Height	2988×1970×1812	2988×1970×1812	2988×1970×1812	2988×1970×1812	mm
Weight	4950	5000	4950	5000	kg
Tailstock					
Taper Center	MT5	MT5	MT5	MT5	
Tailstock travel	605	605	605	605	mm
Maximum holding workpiece length	755	735	755	735	mm
Rapid traverse	5.5	5.5	5.5	5.5	m/min

*All specifications subject to change without notice.

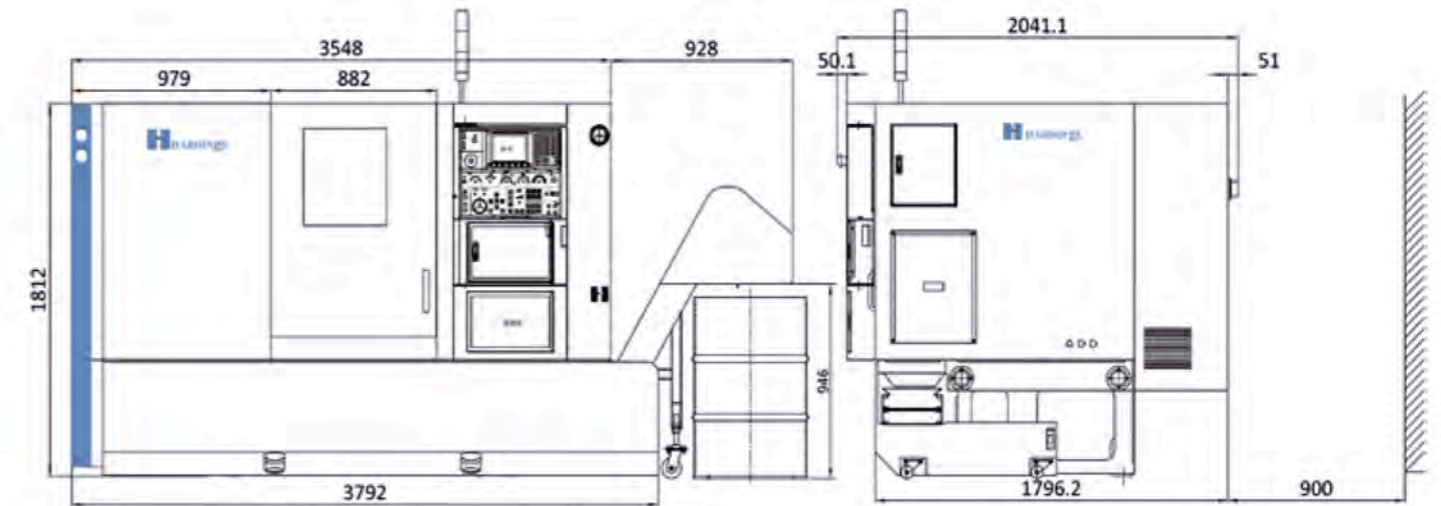

	GS 200/66L Plus	GS 250L Plus	GS 200/66M L Plus	GS 250M L Plus	
Spindle					
Spindle nose	A2-6	A2-8	A2-6	A2-8	
Spindle hole diameter	76	89	76	89	mm
Three-jaw chuck holding capacity	8"Ø200	10"Ø254	8"Ø200	10"Ø254	mm
Draw tube clamping	Hydraulic	Hydraulic	Hydraulic	Hydraulic	
Driving System					
Spindle motor power	15/18.5	15/18.5	15/18.5	15/18.5	kW
Spindle max. speed	4200	3500	4200	3500	rpm
Spindle output torque	335/15min	401/15min	335/15min	401/15min	Nm
X axis servo motor power	1.8	1.8	1.8	1.8	kW
Z axis servo motor power	3	3	3	3	kW
Processing Range					
Swing over way covers	650	650	650	650	mm
Max. turning length	1020	1000	1020	1000	mm
Max. machining diameters	411	411	326	326	mm
Through draw tube bore diameter	Ø66	Ø78	Ø66	Ø78	mm
X/Z axis					
X axis travel (BMT turret)	—	—	217.5	217.5	mm
X axis travel (T-type turret)	216.5	216.5	—	—	mm
Z axis travel	1050	1050	1050	1050	mm
X/Z axis rapid traverse rate	30	30	30	30	m/min
Turret					
Driver of turret	Servo motor	Servo motor	Servo motor	Servo motor	
Number of tool stations	12	12	12	12	
Square shark size	25	25	25	25	mm
Boring tool holder dia.	40	40	40	40	mm
Tool change time (T-T)	0.3	0.3	0.3	0.3	sec
Driving tool speed	—	—	4000	4000	rpm
Driving tool power	—	—	5.5	5.5	kW
Coolant system					
Cool tank capacity	290	290	290	290	L
Cut pressure	2.8	2.8	2.8	2.8	bar
Machine Size					
Length*Width*Height	3549×1970×1812	3549×1970×1812	3549×1970×1812	3549×1970×1812	mm
Weight	5550	5600	5550	5600	kg
Tailstock					
Taper Center	MT5	MT5	MT5	MT5	
Tailstock travel	940	940	940	940	mm
Maximum holding workpiece length	1050	1050	1050	1050	mm
Rapid traverse	5.5	5.5	5.5	5.5	m/min

*All specifications subject to change without notice.